

# Eckschneider

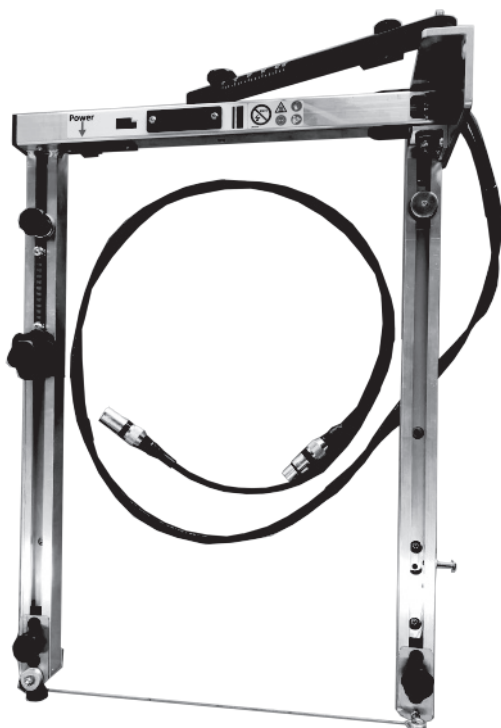

**DE** | Sicherheitshinweise | Schnittvarianten | Justierung | Ersatzteilliste  
**FR** | Instructions de sécurité | Variantes de coupes | Ajustage | Nomenclature  
**IT** | Avvisi di sicurezza | Varianti di taglio | Torsiometrica | Lista parti di ricambio  
**EN** | Safety Instructions | Cutting variants | Adjustment | spare parts list

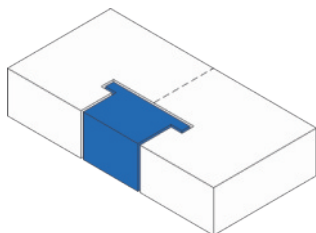
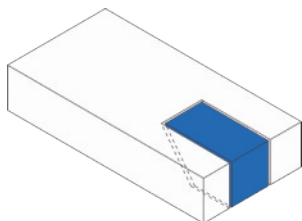
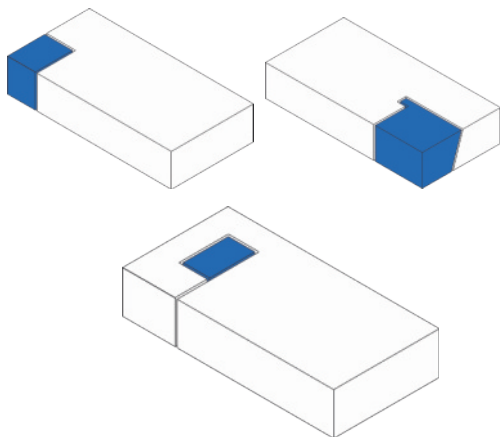

### **DE | Sicherheitshinweise - Vorwort**

Diese Anleitung ist die Grundlage zur Bedienung des Glühdraht-Schneidegeräts. Sie verdient Ihre volle Aufmerksamkeit.

Bevor Sie mit irgendwelchen Arbeiten an oder mit dem Gerät beginnen, verpflichten wir Sie, die vorliegende Anleitung und die separaten Sicherheitsbestimmungen bis zum Schluss sorgfältig durchzulesen. Bestehen irgendwelche Unklarheiten, sprechen Sie uns umgehend dazu an. Nehmen Sie das Gerät nicht in Betrieb solange Unklarheiten bestehen. Mit der Inbetriebnahme des Gerätes bestätigen Sie, dass Sie die Anleitung gelesen und verstanden haben und somit die Betriebsverantwortung übernommen haben. Dieses Gerät darf von Kindern ab 8 Jahren sowie unerfahrenen Personen nur unter Aufsicht von dazu berechtigtem Personal montiert, in Betrieb gesetzt, bedient, betrieben, gewartet und gereinigt werden.

### **FR | Remarques de sécurité concernant les coupeuses à filament incandescent – Préface**

Ce mode d'emploi est la base pour le maniement de la coupeuse à filament incandescent. Veuillez le consulter avec beaucoup d'attention.

Avant de commencer quelques travaux que ce soit ou avant d'utiliser la coupeuse, nous vous engageons à lire le présent mode d'emploi et les remarques de sécurité séparé à minutieusement jusqu'à la fin. S'il y a quelques confusions, n'hésitez pas à nous contacter immédiatement. Ne mettez pas la coupeuse en service tant qu'il y a des confusions. Avec la mise en service de la coupeuse, vous confirmez que vous avez lu le mode d'emploi et que vous l'avez compris et ainsi vous prenez en charge la responsabilité du bon fonctionnement. Ce dispositif doit être monté pour les enfants de 8 ans et des personnes inexpérimentées, sous la supervision du personnel autorisé, mis en place, exploité, exploité, entretenu et nettoyé.

### **IT | Avvisi di sicurezza per la trancia a filo incandescente - Premssa**

Le presenti istruzioni sono la base per l'uso della taglierina a filo incandescente.

Prima di iniziare qualsiasi operazione sull'apparecchio o con l'apparecchio, vi chiediamo di impegnarvi a leggere attentamente le presenti istruzioni e le avvertenze di sicurezza separate fino alla fine. Qualora dovessero esservi dei punti non chiari, contattateci immediatamente e parlatecene. Non mettete in funzione l'apparecchio fino a quando sussistono questi dubbi. Mettendo in funzione l'apparecchio, confermate di avere letto le istruzioni e di esservi assunto la responsabilità del relativo esercizio. Questo dispositivo deve essere montato per bambini da 8 e persone inesperte sotto la supervisione di personale autorizzato, istituito, gestito, operato, manutenzione e pulizia.

### **EN | Hot wire cutter safety advice and instructions manual - Foreword**

These instructions must be read before using the hot wire cutter. Please read them carefully.

Before you begin any work or begin using the tool, you must carefully read this introduction and the separate safety advice. If you have any queries, please do not hesitate to contact us. Do not use the tool if you continue to be unsure about any aspect. When you begin to use the tool, you tacitly confirm that you have read and understood the introduction and that you take full responsibility for the operation of the tool. This device must be mounted for children ages 8 and inexperienced persons under the supervision of authorized personnel, set up, operated, operated, serviced, and cleaned.

**DE** Inbetriebnahme | **FR** Mode d'emploi type  
**IT** Istruzioni per l'uso modello | **EN** Setting the Device Up

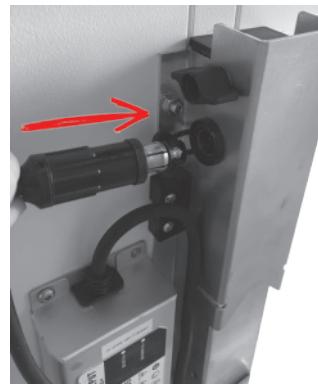
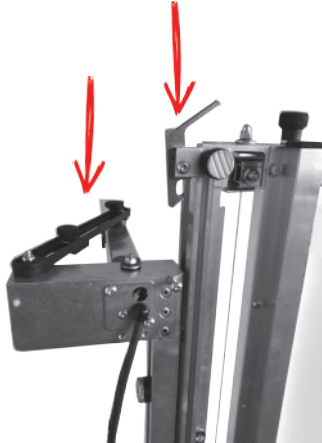
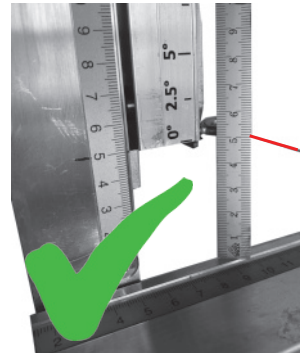
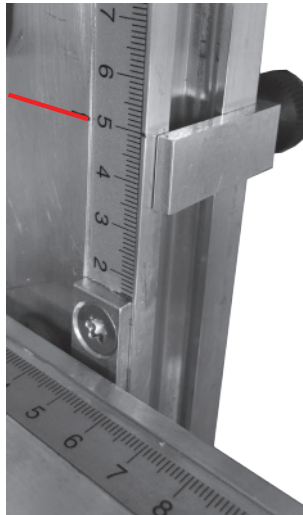
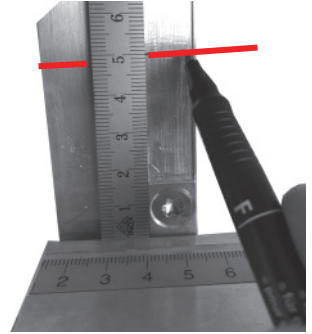
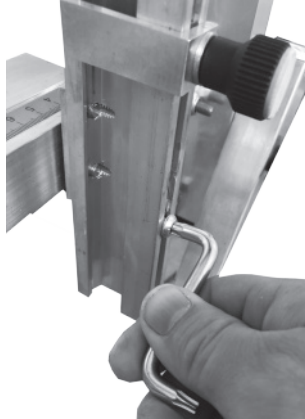
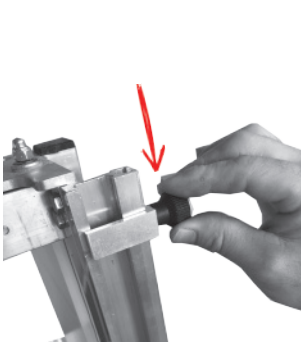

**DE** Inbetriebnahme | **FR** Mode d'emploi type  
**IT** Istruzioni per l'uso modello | **EN** Setting the Device Up

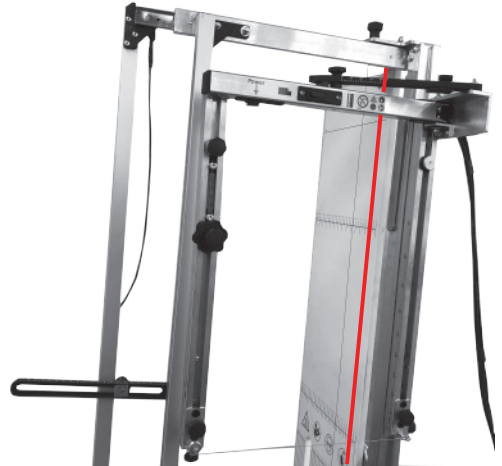
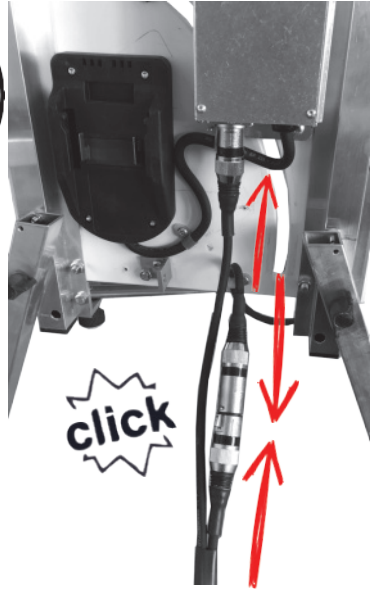
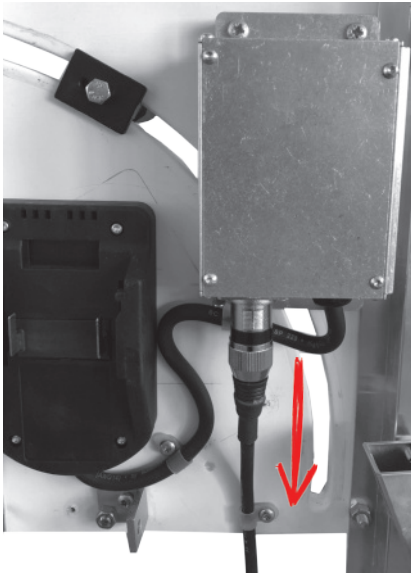

**DE Schnittvarianten | FR Variantes de coupes  
IT Varianti di taglio | EN Cutting variants**



**New 10 °**

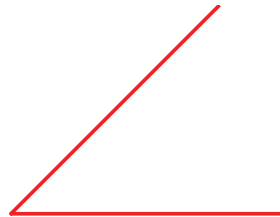
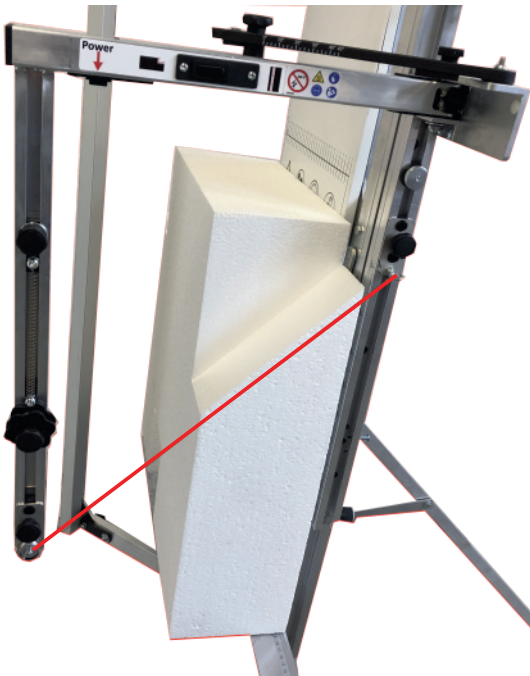
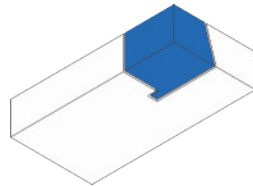
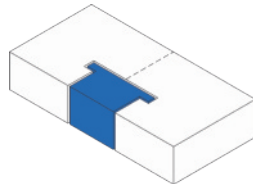

**45 °**

**DE** Schnittvarianten | **FR** Variantes de coupes  
**IT** Varianti di taglio | **EN** Cutting variants

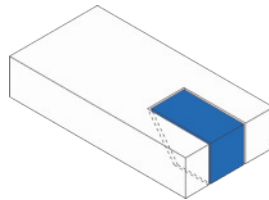
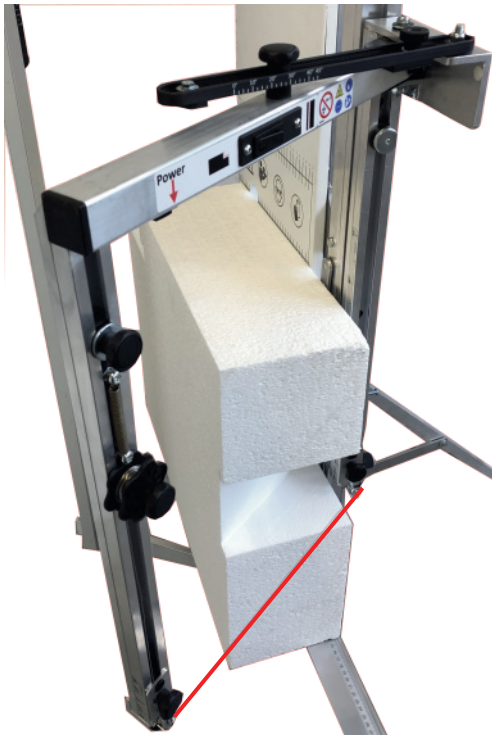
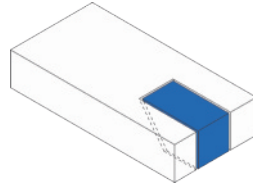
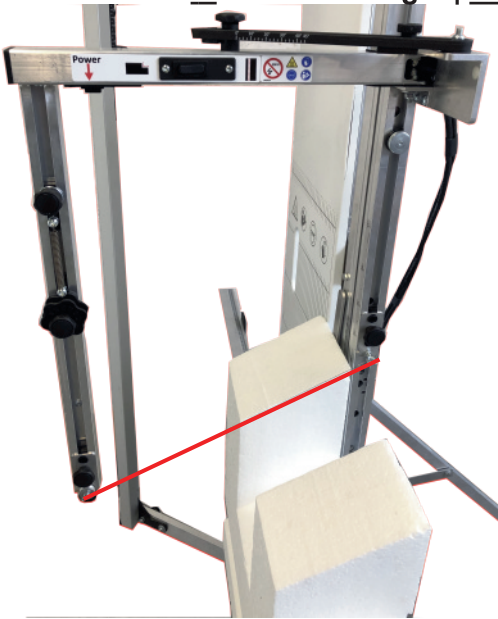

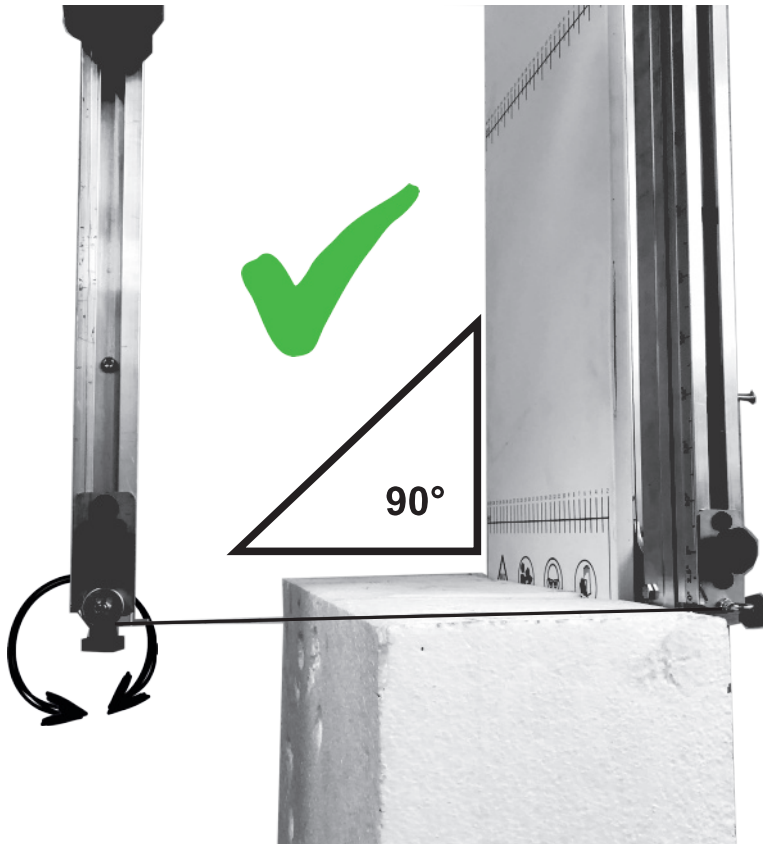

**DE Ersatzteilliste | FR Nomenclature  
IT Lista parti di ricambio | EN Spare parts list**

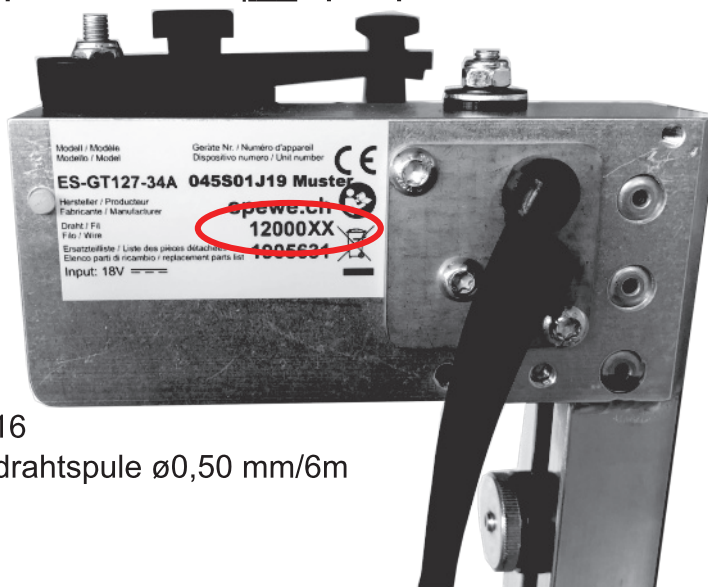

1200016  
Ersatzdrahtspule  $\varnothing$ 0,50 mm/6m



1200018  
Ersatzdraht  $\varnothing$  0,65 mm / 20 m

**DE Ersatzteilliste | FR Nomenclature  
IT Lista parti di ricambio | EN Spare parts list**

**1905631 Ersatzteilliste Eckschneider**

**Download [www.spewe.ch](http://www.spewe.ch)**

**Servicestellen | Points de service | Centri di assistenza | Services**

Schweiz | Suisse  
Svizzera | Switzerland

**Spewe AG**  
Hauptstrasse 332  
CH-5326 Schwaderloch  
Fon +41 56 203 03 30  
[info@spewe.ch](mailto:info@spewe.ch)

Europäische Union | Union européenne  
Unione europea | European Union

**Dosteba GmbH**  
Aspenhaustrasse 6  
D-72770 Reutlingen  
Fon +49 7121 30177 10  
[dosteba@dosteba.de](mailto:dosteba@dosteba.de)

